

Assembly Manual

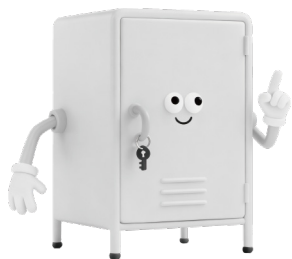

Item: Outdoor Waste Bin Box With Plant Roof ,2 Bin



Dear Customer,
Thank you for choosing our product! This manual covers accessories, installation steps and safety notes.
Enjoy your experience!



90 – 120 min



Check the quantity of parts



Prepare the tools



On-carpet installation

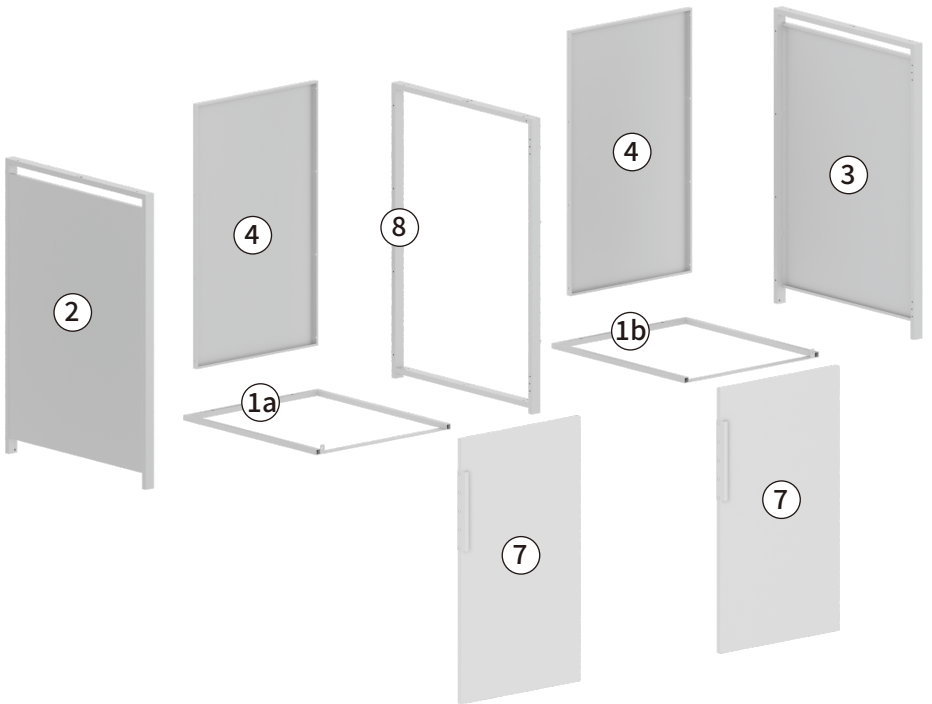
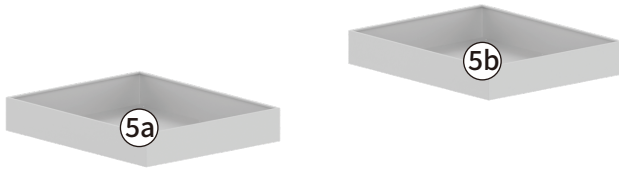

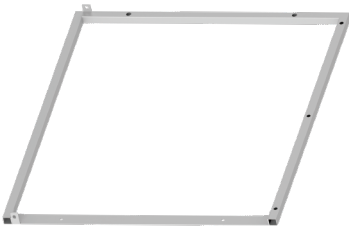

1a Bottom Frame, Left
1x

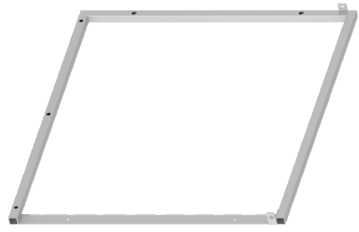

1b Bottom Frame, Right
1x



2 Side panel, Left
1x



3 Side panel, Right
1x



4 Back panel
2x

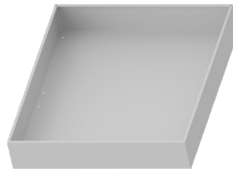

5a Plant roof, Left
1x

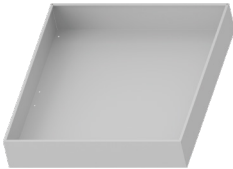

5b Plant roof, Right
1x



7 Door
2x



8 Middle frame
1x



K10 Screws
16x



G24 Screws
48x



G25 Screws
4x



G26 Screws
6x



G28 Screws
10x



L37 Screws Rings
16x



A13 Bolt
8x

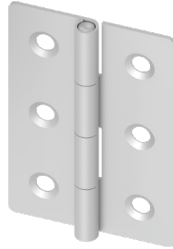

A14 Hinge
4x

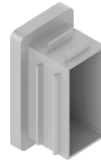

A16 Cover pad
6x

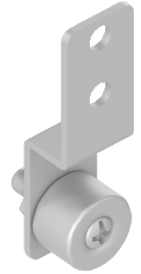

A17 Magnet
4x



A18 Metal hook
4x



A20 Metal string
2x



A19 Handle
2x



T10 Wrench
1x



L60 Pad
4x

1

A16
6x

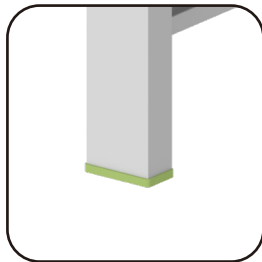
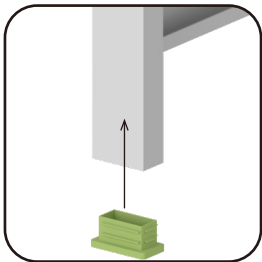
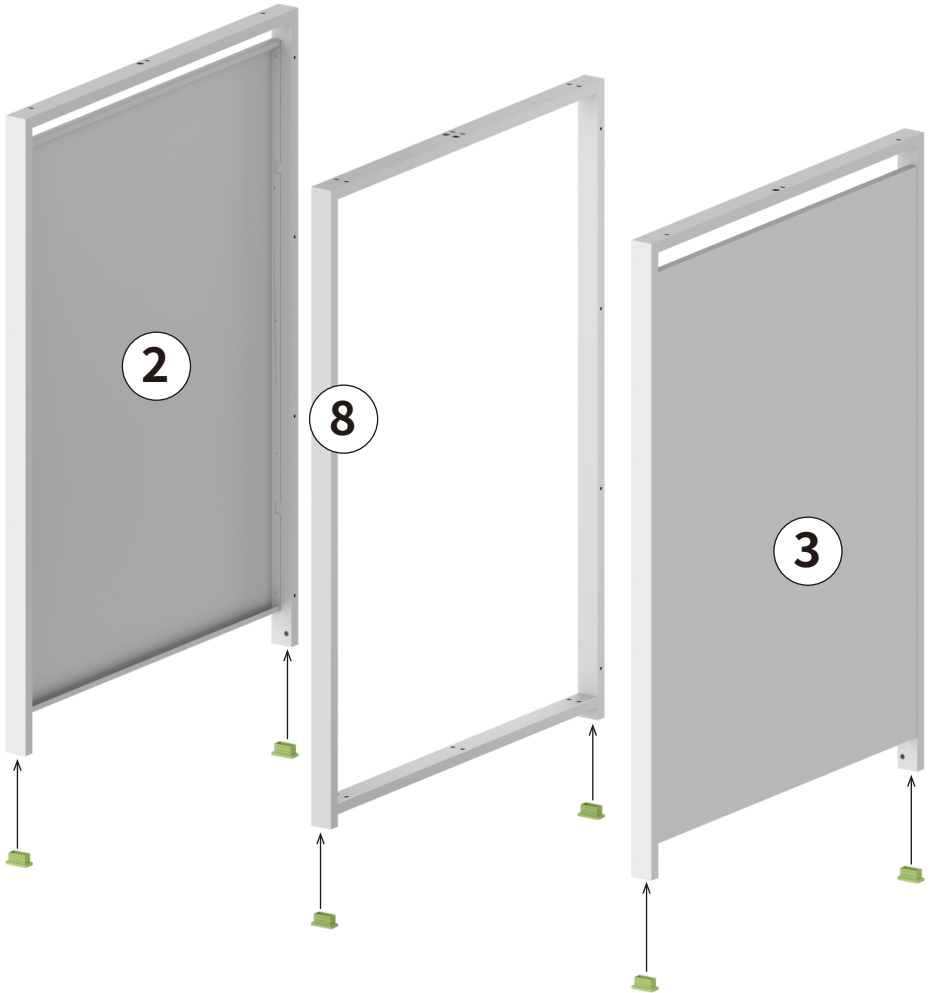
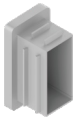

2

T10

1x



G26

6x

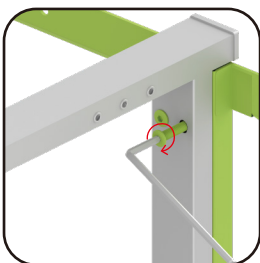
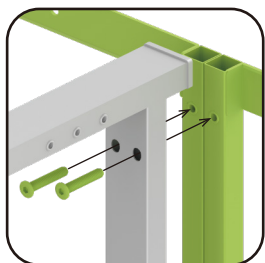
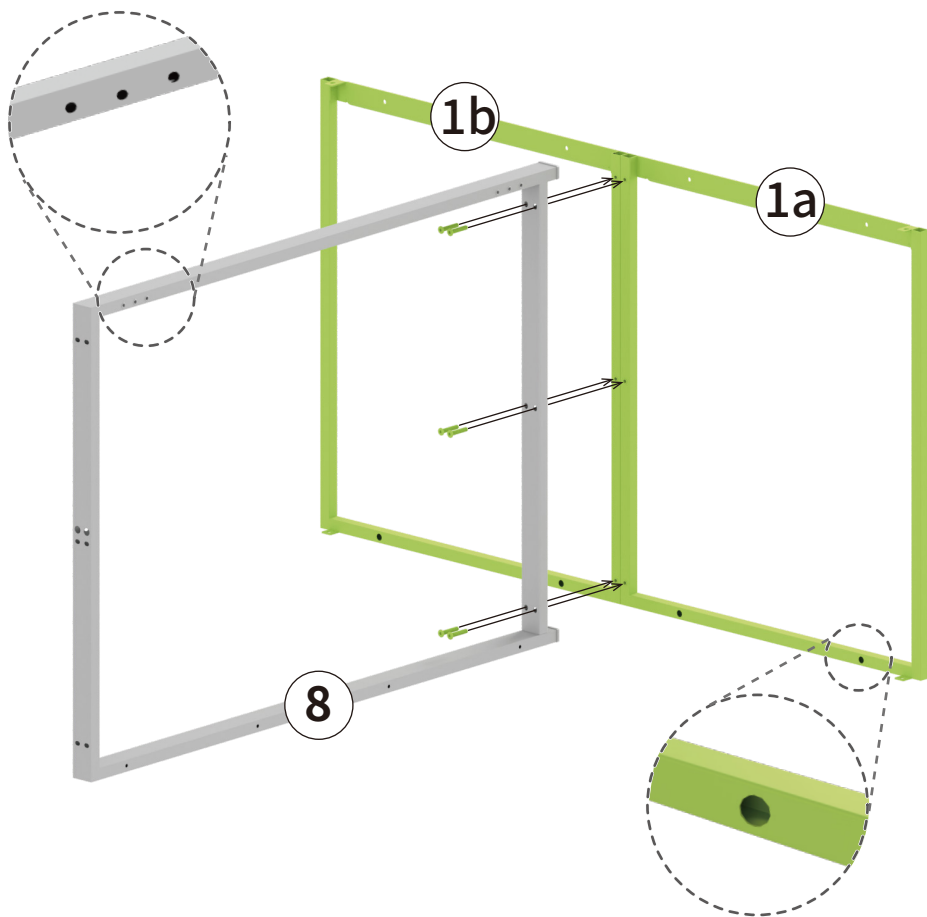

3

G25
4x

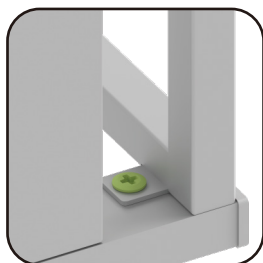
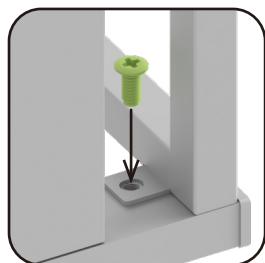
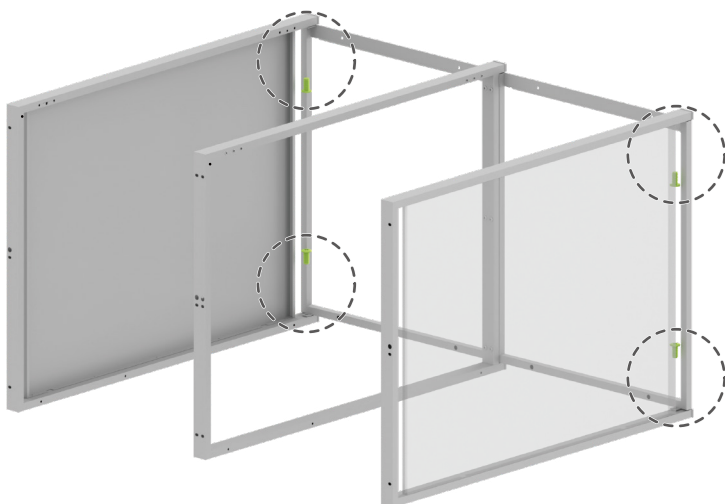
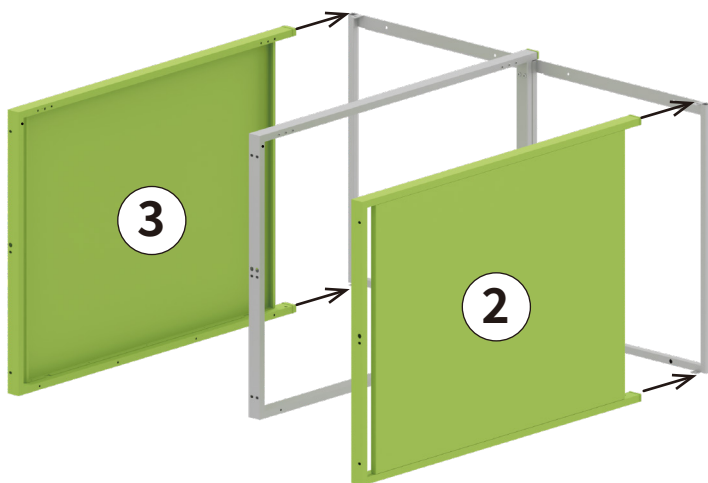

4

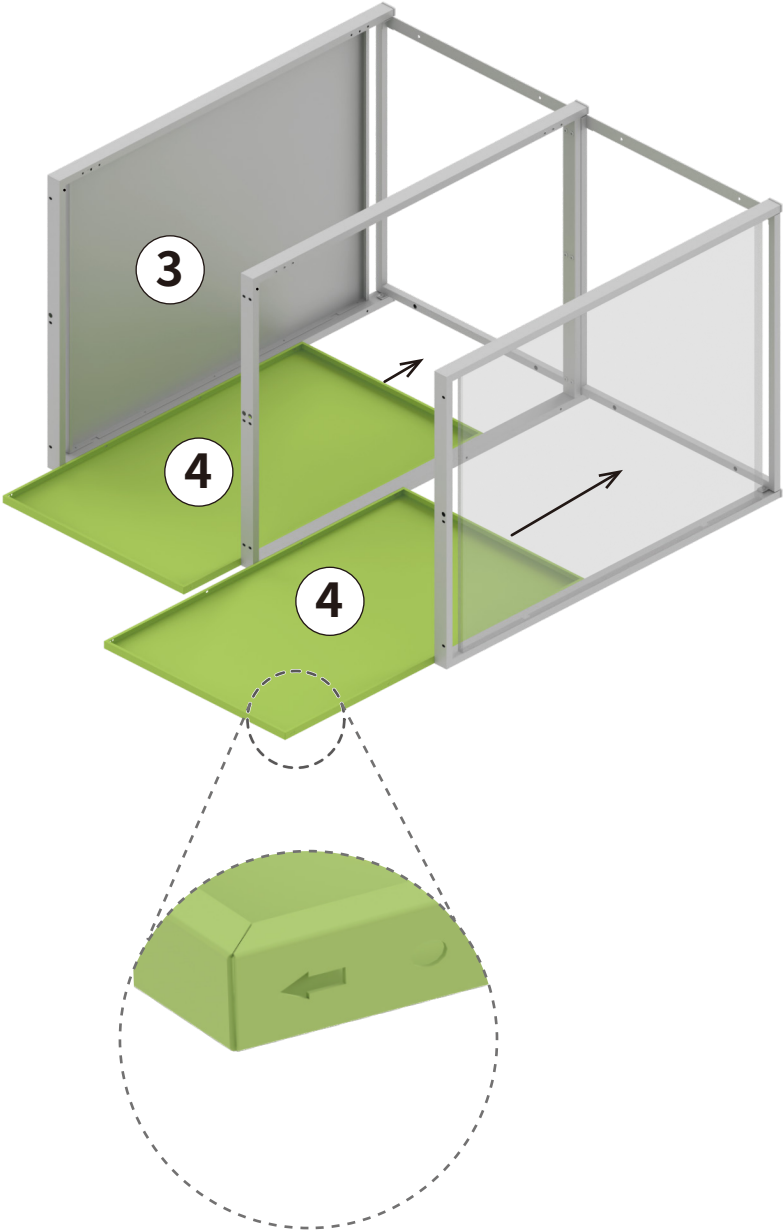

5

G24
16x

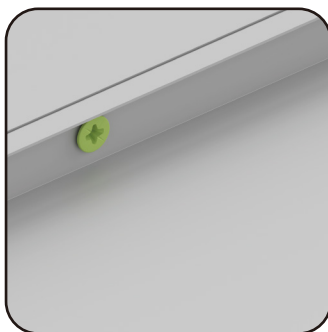
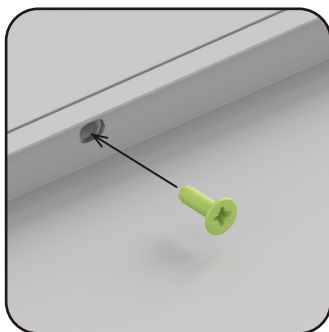
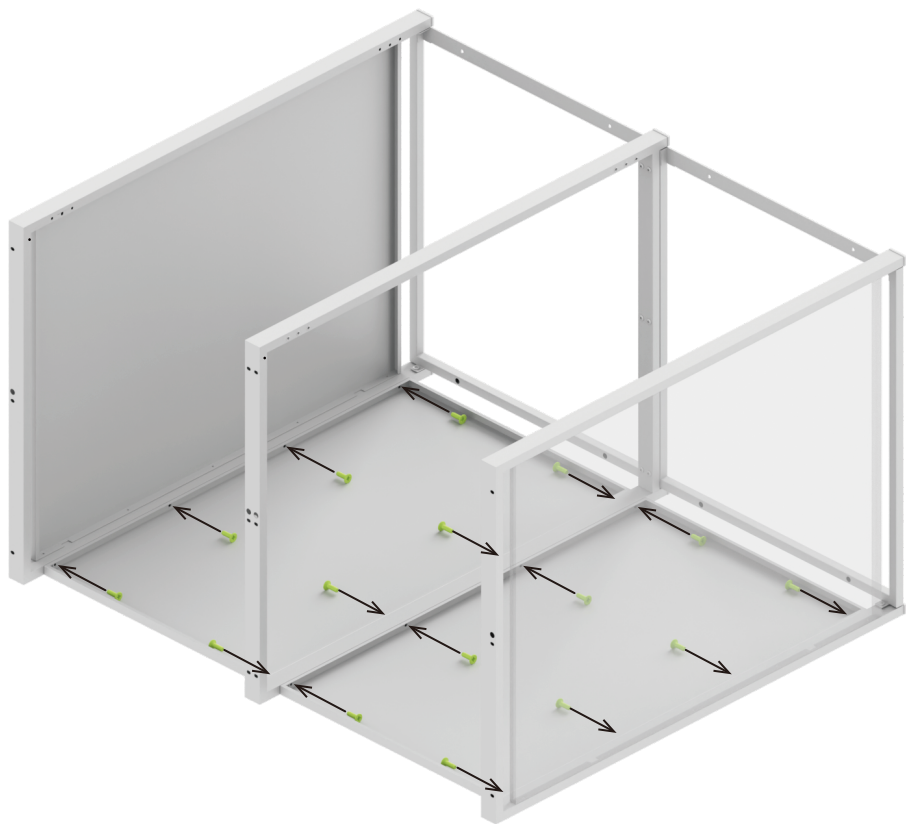

6

A17
4x



G24
8x

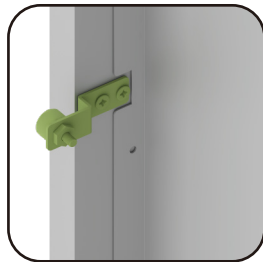
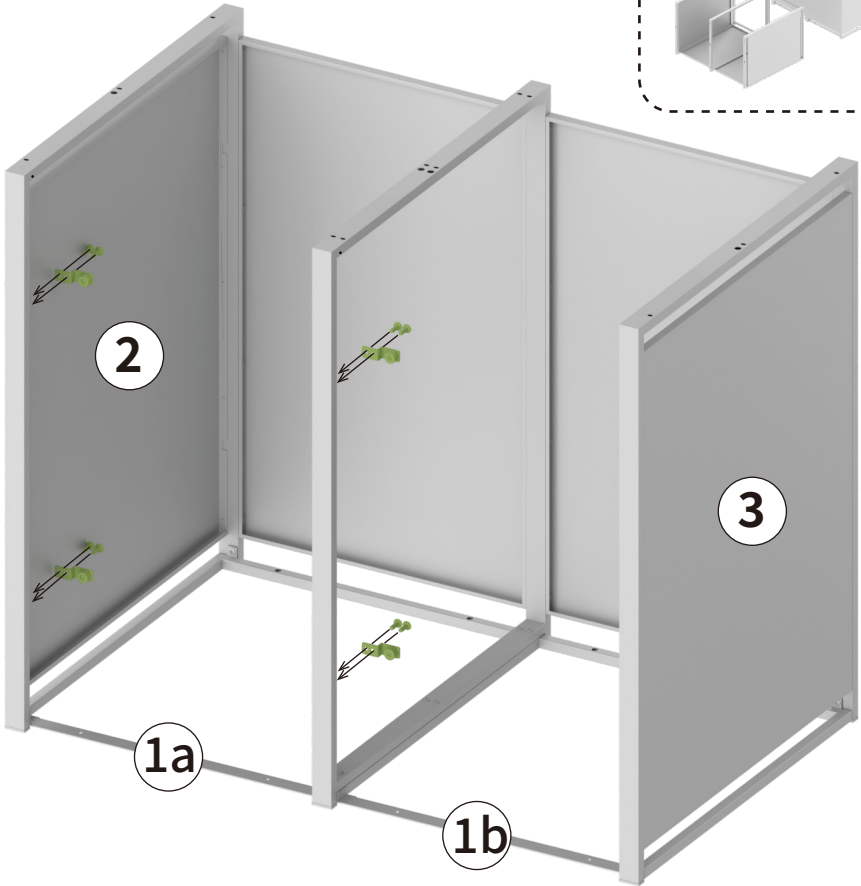
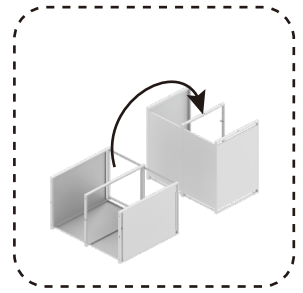

7



8

K10

16x



L37

16x

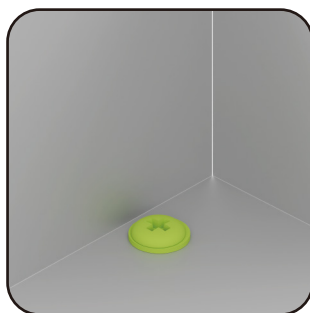
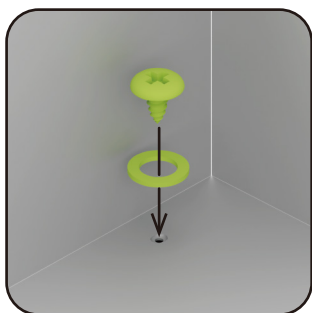
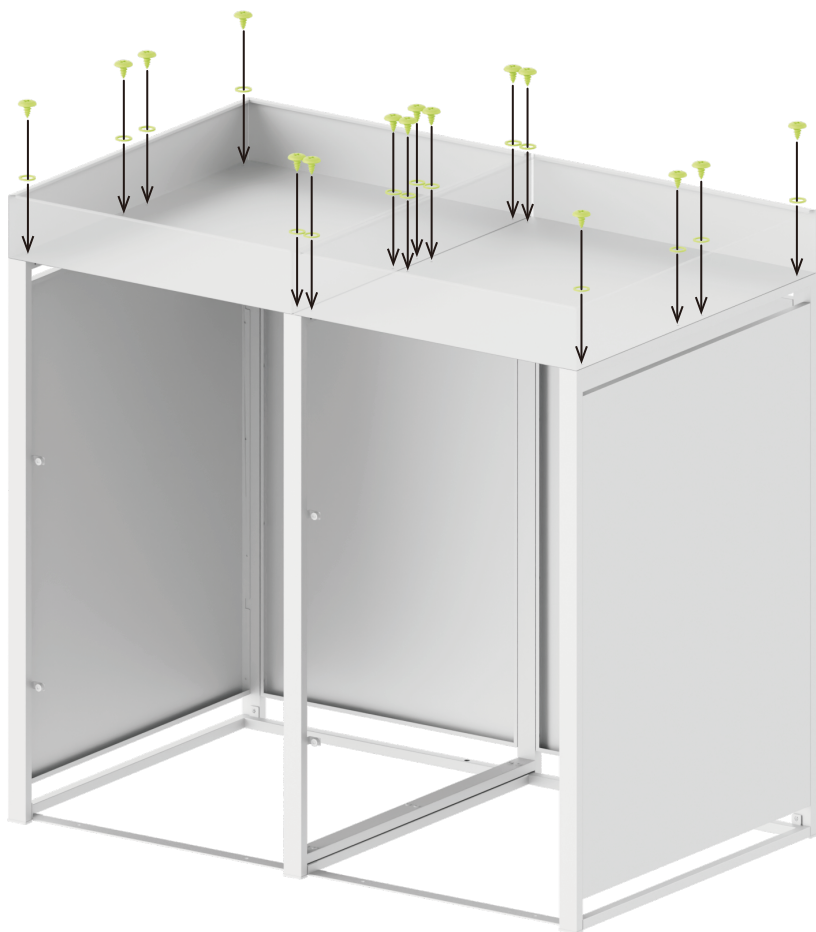

9

A14
4x



G24
12x



2x

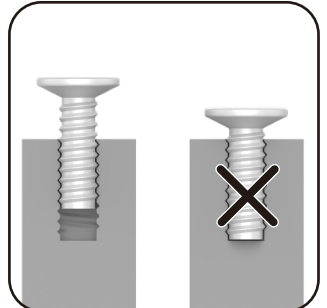
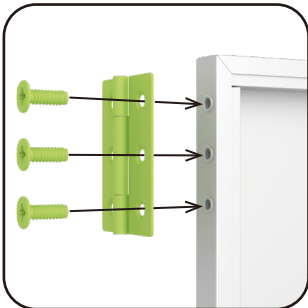
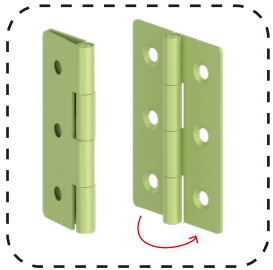

10

G24
6x

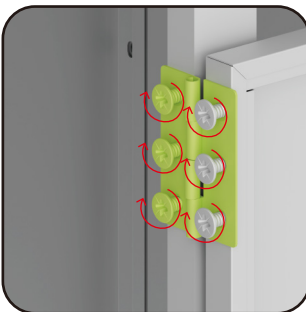
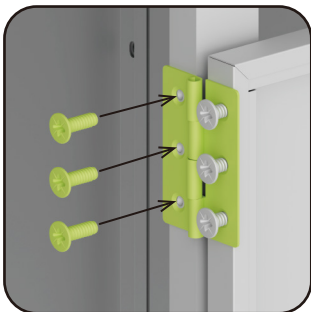
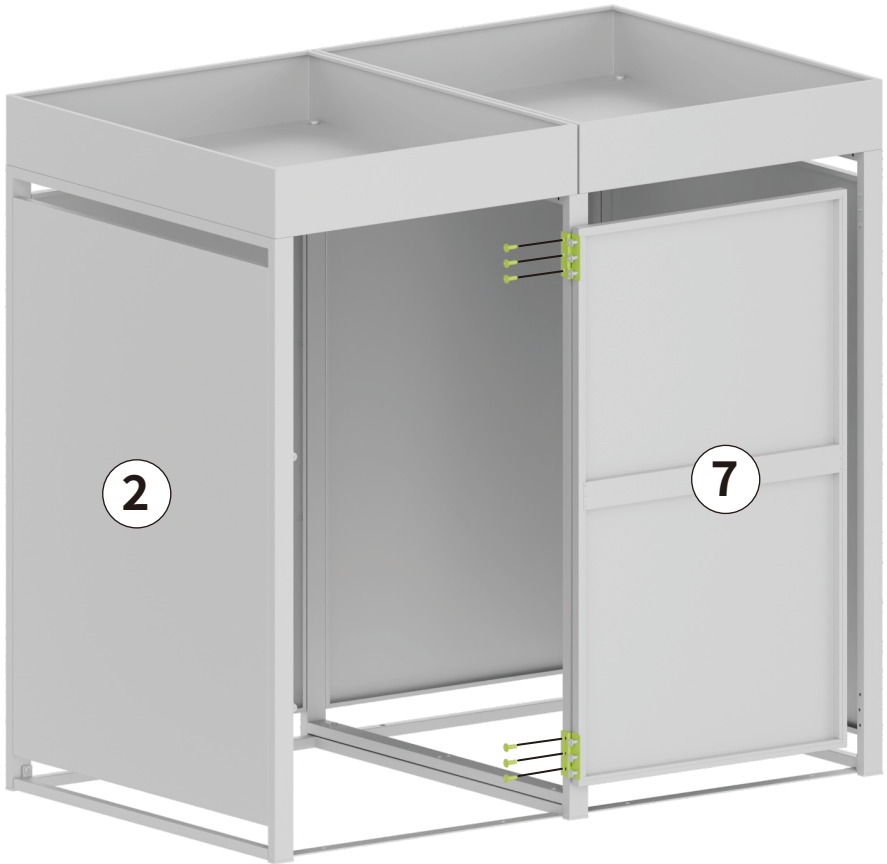

11

G24
6x

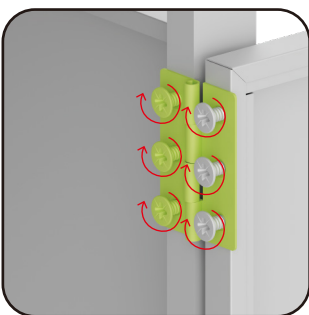
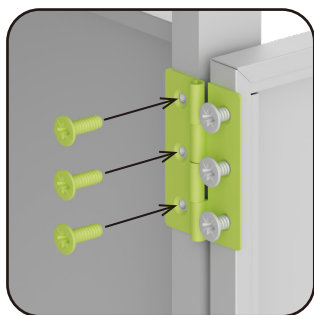
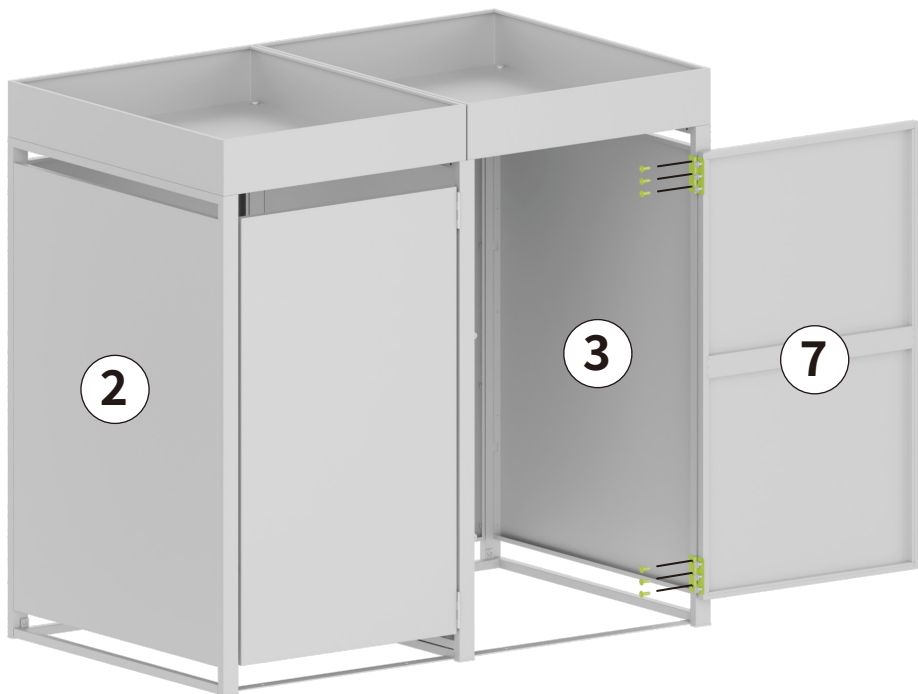

12

A19
2x



G28
10x

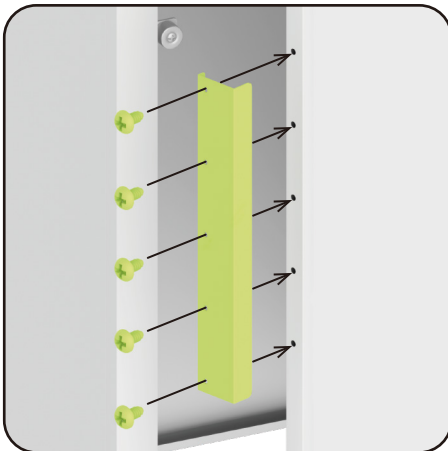
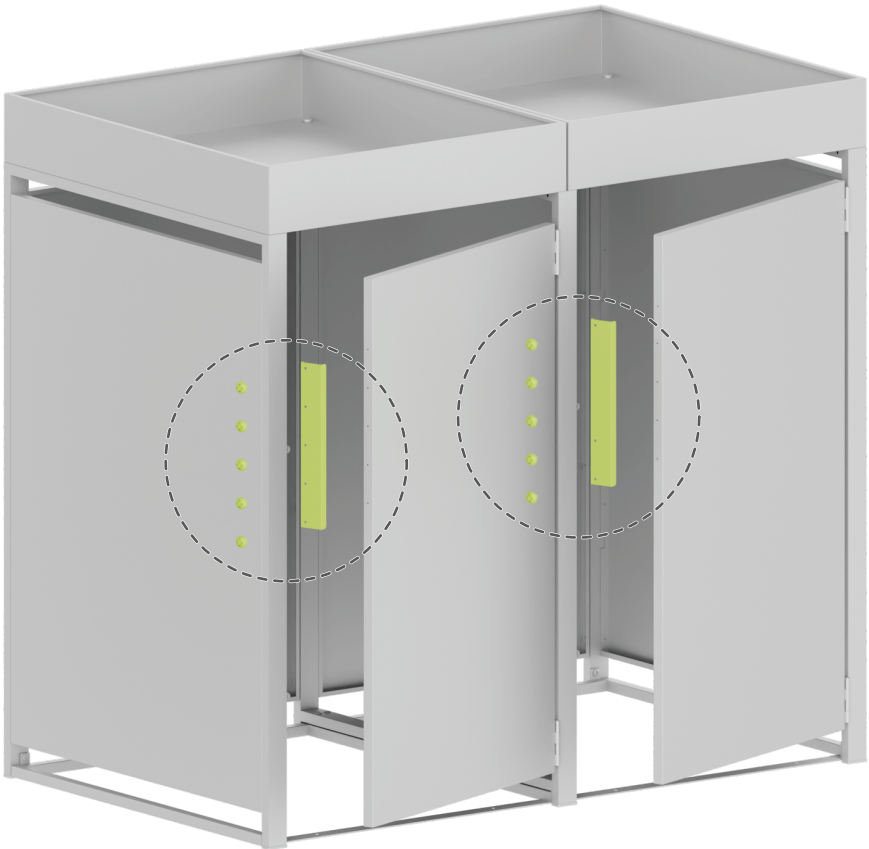

13

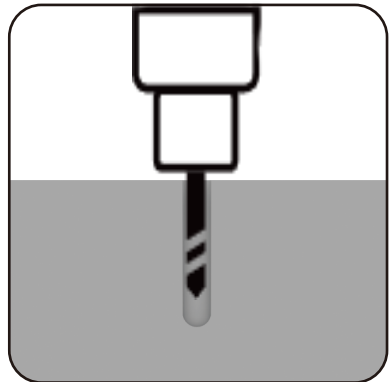
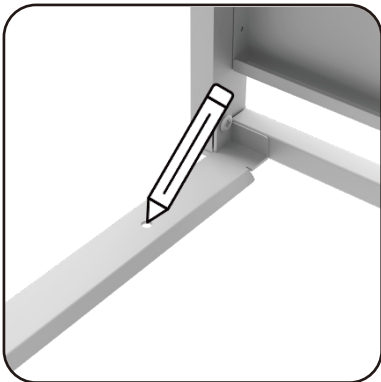

14

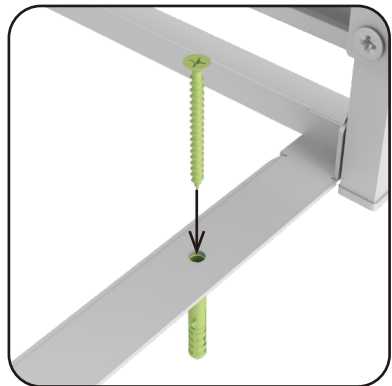
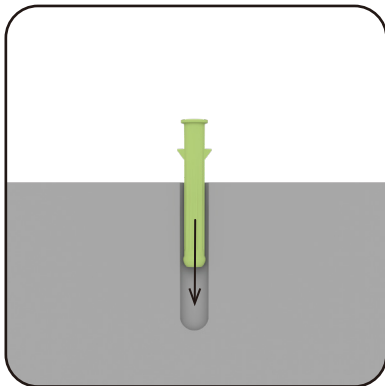
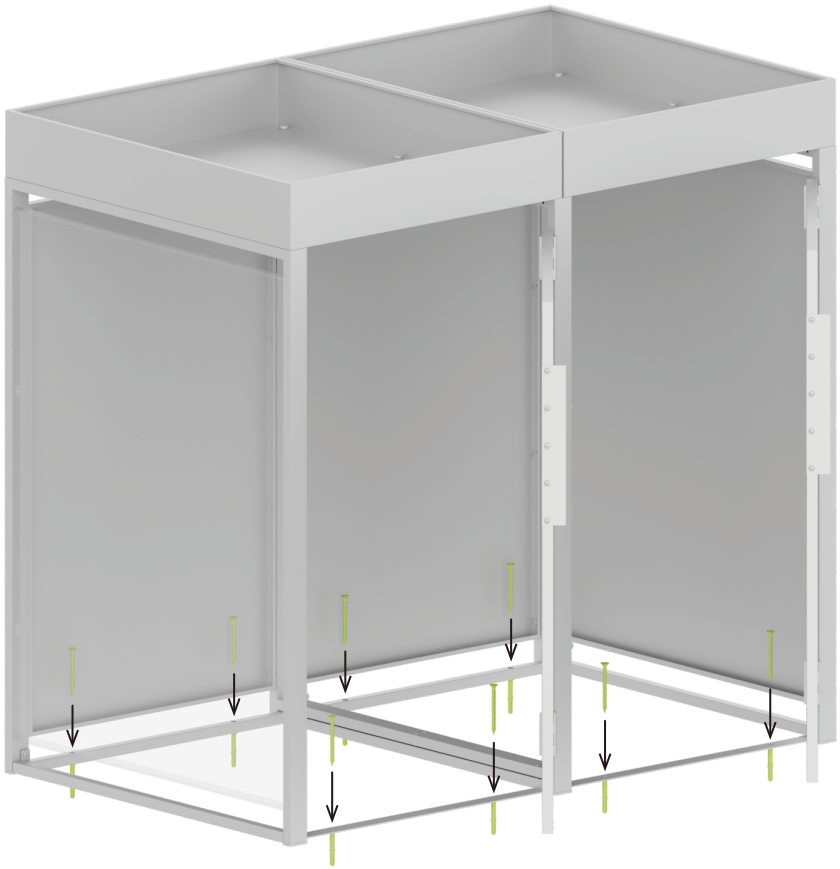
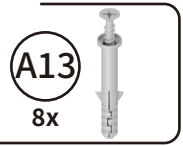

15

L60
4x

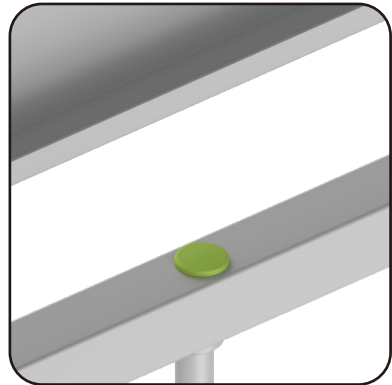
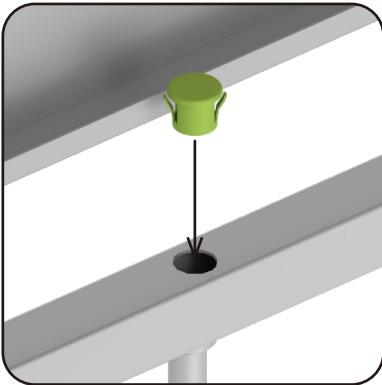
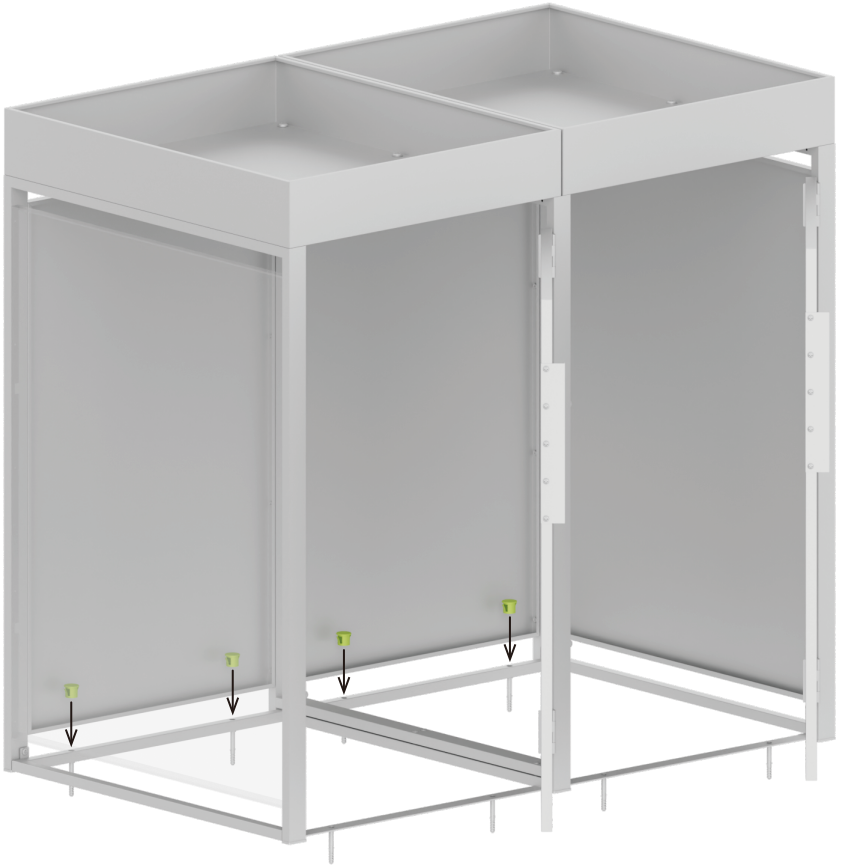



17

A18

4x



A20

2x

